



嵌入式單頭氣體煮食爐

Built-in single burner gas hob

LGC01CNB-TN (香港煤氣 HK TOWN GAS)

LGC01CNB-LN (香港石油氣 HK LP GAS)

用戶手冊 User's Manual

感謝您購買本公司的產品，使用產品前，請務必注意安全操作須知。請在閱讀後，妥善保管好說明書以備查閱。
因為本公司的產品會不斷改進，如有變更，恕不另行通知。

Thank you for purchasing our product. Before using the product make sure that you have followed the safety instructions. Please keep this manual for future reference. There will be increase improvements on our products. Information is subject to change without prior notice.

總代理：星暉爐具貿易有限公司 Sole Agency: Lighting Gas Stoves Trading Ltd.
香港新界荃灣半山街10-16號雷華工業大廈13樓C&D室
Flat C&D, 13/F., Fou Wah Industrial Bldg., 10-16 Pun Shan Street, Tsuen Wan, N.T, H.K.
Tel: (852) 2490 0073

Further information can be found at www.lightinggas.com.hk
© Copyright by Lighting Gas Stoves Trading Ltd.

內容 Content

| | |
|--|----------|
| 氣體接駁需知 Gas connection and warning | P.1 - 2 |
| 各部名稱 Parts identification | P.2 |
| 安裝前須知 Precautions before installation | P.3 |
| 使用方法 Operating instructions | P.3 - 6 |
| 清潔及保養 Cleaning and maintenance | P.7 - 8 |
| 常見故障及處理方法 Trouble shooting | P.9 - 10 |
| 技術規格 Specifications | P.11 |

氣體接駁需知 Gas Connection and Warning

所有類型的氣體用具

使用認可印有機電工程署批准標記(例如·機電工程署批准 EMSD APPROVAL GTXXXX)的氣體接駁喉管連接爐具,或使用機電工程署接納的其他恰當方法。

注意!

根據香港氣體安全條例,任何氣體裝置工程,包括爐具和接駁喉管的安裝,必須由註冊氣體裝置技工執行,而該技工已於相關的氣體工程類別註冊及受聘於註冊氣體工程承辦商。

All Types of Gas Appliances

Use approved gas tubing bearing Electrical and Mechanical Services Department (EMSD) approval mark (such as: 機電工程署批准 EMSD APPROVAL GTXXXX) for connection to appliances, or other appropriate methods accepted by EMSD.

Attention!

According to the Gas Safety Ordinance of Hong Kong, any gas installation works including the installation of appliances and connection tubing must be undertaken by registered gas installers who are registered for the appropriate classes and are employed by registered gas contractors.

嵌入式煮食爐特別注意事項

- 1 當在灶櫃面安裝嵌入式氣體煮食爐時,灶櫃應設有透氣設施,以確保煮食爐在使用時操作正常,如果安裝爐具靠近於易燃物料附近(如木牆,木架),兩側的安裝間距需要有15厘米以上。



- 2 不應將易燃物料、噴霧及壓縮容器放置在灶櫃內。
- 3 切勿安裝外置氣體穩壓器。
- 4 切勿使用並非由製造商供應的配件,例如錫紙碟。
- 5 此煮食爐的面板是用微晶玻璃製造,較一般玻璃安全。唯使用嵌入式玻璃面板煮食爐時還須注意以下事項,以避免造成玻璃面板爆裂。
 - a. 經常清潔爐頭組件以保持爐蓋焰孔暢通,如溢出的食物及汁液,應在爐頭組件冷卻後儘快妥善清理。
 - b. 如煮食爐出現不尋常聲音,應立即停用並安排氣體供應公司或爐具進口商檢查。
 - c. 請勿放置過小、過大或過重的煮食器皿於爐架上,以免損壞爐架及令過多熱量反射回爐面,造成損壞。此煮食爐的最高負載重量為10公斤,平底鍋具最大直徑為26cm。
 - d. 切勿以硬物撞擊或將重物放置於玻璃面板。

Additional Precautions for Built-in Hobs

- 1 When installing a built-in hob on top of a stove cabinet, please check that there is provision for ventilation at the cabinet to ensure proper operation of the gas hob. If the unit is to be installed close to combustible surroundings (such as wooden walls, wooden shelves), it should be installed at least 15cm from the side walls. The unit should be installed with a distance of at least 15cm away from surrounding combustible materials.

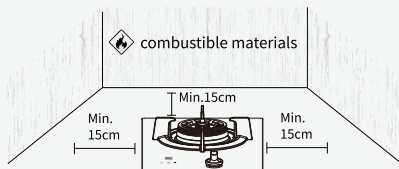

- 2 Do not store any flammable materials, sprays or pressurized containers inside the stove cabinet.
- 3 Do not install with an external gas governor.
- 4 Do not use any additional fitting such as aluminum tray that is not supplied by the manufacturer.
- 5 The panel of this built-in hob is made of ceramic glass, which is safer than normal glass for this appliance. However, the following safety precautions for using built-in hobs with a glass top panel should also be noted to prevent the glass top panel from breaking.
 - a. Clean the burner assembly frequently to maintain a clear gas passage on the burner cap. Clean and tidy up the flame distributor after spillage of food and liquid once the burner assembly cools down.
 - b. Turn off the gas appliance immediately if abnormal noise propagates from the gas appliance and contact the gas supply company or gas hob importer for inspection.
 - c. Do not use undersize, oversize or overweight cooking pots or receptacles, or they will damage the rack and cause excessive heat to be reflected back onto the range surface. This may increase the temperature of this area and may cause damage. The maximum load weight for this appliance is 10kg, the maximum pan size is 26cm.
 - d. Do not impact the glass surface with hard objects or place heavy objects on the glass surface.

各部名稱 Parts Identification

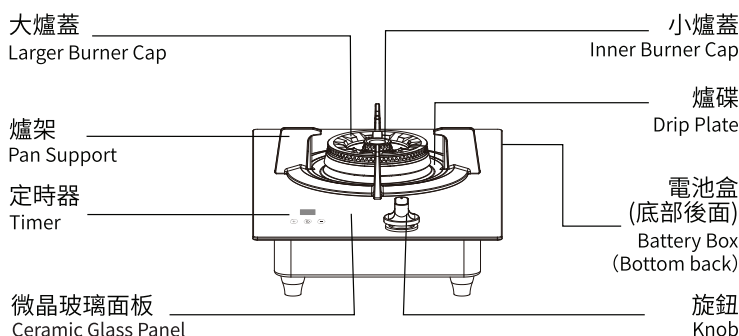

LGC01CNB-TN/LGC01CNB-LN

圖片只供參考，實際外形請參考實物。

The figure is for reference purpose only. Please refer to the actual component parts.

安裝前須知 Precautions Before Installation

- 1 檢查爐具的零件是否齊全,完好。若發現有不齊或破損,請與購買商聯絡。
 - 2 在您選定的台面安裝位置,請按包裝箱內的台面開窿樣板尺寸開孔。
 - 3 於廚櫃枱面安裝嵌入式氣體煮食爐時,灶櫃應設有活風透氣設施,以確保煮食爐在使用正常。不要儲存任何易燃物料、噴霧或壓力容器在灶櫃內。
 - 4 爐具需與牆壁保持足夠距離,此爐具的安裝位置應與周圍易燃物料距離15厘米以上,若爐具周圍與易燃物品沒有充分的空間,請安裝防熱板。
- 1 Check the quantity of the components and make sure all items are there. If there are some items missing or damaged in the packaging, please contact the dealer.
 - 2 Cut out the dimensions for the cabinet according to the template provided for reference on your selected countertop area.
 - 3 When installing a built-in gas hob on top of a stove cabinet, please check that there is provision for ventilation at the cabinet to ensure proper operation of the gas hob. Do not store any flammable materials, sprays or pressurized containers inside the stove cabinet.
 - 4 Allow the minimum required space from walls. A build-in hob should be installed with a distance of at least 15cm away from surrounding combustible materials. If the space between the cooker and combustible materials cannot be maintained as specified, make sure to install a heat-proof panel.

使用方法 Operating Instructions

1 點火

- a. 請向下按緊旋鈕,並以逆時針方向旋至 [🔥] 位置,維持按壓約10秒鐘。
放手時,請確認爐頭維持於燃燒狀態,如爐火仍未點燃,將旋鈕旋轉回 [•] 位置,
- b. 等待最少於一分鐘後才可重覆以上步驟。

注意

當爐具被重新安裝或長時間沒有使用時,可能須要較長時間才可燃點爐火。

2 火力調節

順時針或逆時針旋轉即可進行火力調節

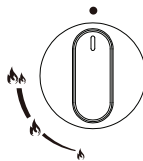

- 關閉
- 🔥 大火
- 🔥 小火

LGC01CNB-TN
LGC01CNB-LN

3 熄火

順時針將旋鈕旋至 [•] 位置。

注意

熄火時可能會發出“撲”的聲響,這是正常現象。

1 Ignition

- Press the knob and turn it anti-clockwise to the [🔥] position, then keep pressing for around 10 seconds. Release the knob and check if the flame is already ignited. If not, turn the knob back to the [•] position.
- You may repeat the above steps after at least 1 minute.

Note:

If the stove is not being used for a long time or has just been re-installed, it may take a longer time for ignition.

2 Flame Power Control

Rotate the knob clockwise or anti-clockwise to adjust the flame.

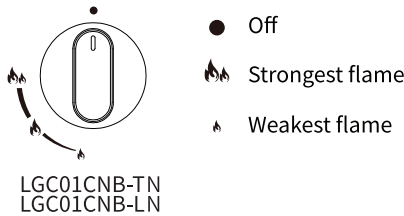

3 Turning Off

Turn the knob in a clockwise direction to the [•] position.

Note:

When turning off, a "POP" sound may be produced. This is normal.

定時器操作方法

- 按正常的操作方法打開爐具確保正常燃燒。
- 長按定時器開關鍵“⏻” 2秒以上，數碼顯示屏顯示幕預設顯示“5”分鐘，並開始閃爍。
- 在顯示屏閃爍期間，使用者根據需要設置的時間，短按“+”或“-”鍵，進行加減調節，時間設置可迴圈調節。
按“+”鍵定時時間分鐘變化如下：
→ 0 → 1 → 2 → . . . → 14 → 15 → 20 → 25 → 30 → 40 → 50 → . . . → 170 → 180 → 0
按“-”鍵定時時間分鐘變化如下：
→ 0 → 180 → 170 → . . . → 50 → 40 → 30 → 25 → 20 → 15 → 14 → . . . → 2 → 1 → 0
長按 + 或 - 則快速調整直至鬆開按鍵。
- 用戶設置好時間後，5秒內不進行加減操作，顯示屏將停止閃爍，定時功能啟動，開始倒數計時顯示。倒數過程中若需要重新調整定時時間，短按“⏻”鍵，此時顯示屏時間開始閃爍，按上述方法按加或減鍵進行調節。
- 定時時間剩餘1分鐘時，顯示屏切換為60秒倒計時狀態，最後10秒同時伴有 1Hz 蜂鳴器提示。定時結束，火焰自動熄滅，同時報警10聲，顯示屏顯示“En”直至關閉旋鈕。

6 使用過程中如果取消定時

- 1) 將定時時間設置為“0”，則5秒之後顯示屏關閉顯示，並退出定時狀態。
- 2) 定時設置或倒數計時過程中需要取消定時，則長按定時器“⏻”鍵2秒以上，此時顯示屏關閉顯示，表示退出定時狀態。

注意

- 1) 本爐具爐頭具有定時功能
- 2) 如使用定時器功能煮食，亦請切勿在無人看管的情況下使用爐具
- 3) 若電源意外斷電或電池供電不足，爐頭將會執行熄火動作
- 4) 此定時器的顯示單位為分鐘，若倒數至1分鐘以下將以秒數為顯示單位

| 定時器故障代碼及處理方法 | | | |
|----------------|---------------------------------------|------|--------------|
| 狀態 | 現象 | 代碼顯示 | 處理方法 |
| “定時結束” 提示 | 提示音和“En”顯示持續10秒後消失之後每隔5分鐘重複提示，直至關閉旋鈕。 | En | 關閉旋鈕重新使用 |
| “熱電偶閥開路” 報警 | 提示音和“E1”顯示持續10秒後消失直至關閉旋鈕。 | E1 | 更換電磁閥或者脈衝點火器 |
| “電池供電不足” 提示 | 提示音和“Lo”顯示持續10秒後消失 | Lo | 更換電磁閥乾電池 |

Operation of Timer

- 1 Turn on the stove according to the normal mode of operation to ensure normal combustion.
- 2 Press and hold the timer switch button "⏻" for more than 2s. The digital display screen is preset to display "5" minutes and then begin to flash.
- 3 While the display screen is flashing, the user can press in short strokes the "⏩" or "⏪" key according to the time required to be set to adjust upward or downward. The time setting can be adjusted in loops.
Press the "⏩" button to change the time. Minute intervals are as follows:
→ 0 → 1 → 2 → → 14 → 15 → 20 → 25 → 30 → 40 → 50 → → 170 → 180 → 0
Press the "⏪" button to change the time. Minute intervals are as follows:
→ 0 → 180 → 170 → → 50 → 40 → 30 → 25 → 20 → 15 → 14 → → 2 → 1 → 0
Press and hold ⏩ or ⏪ for fast adjustment until the button is released.
- 4 After the time is set, the display will stop flashing if there is no adjustment within 5s. The timer function will be initiated and the countdown display will start. To readjust the timing during the timing process, press the "⏻" key in short strokes. The displayed time will then start to flash. Adjust the timing up or down according to the instructions above.

- 5 When the remaining scheduled time reaches 1 minute, the display will switch to the countdown mode of 60s. During the last 10s there will be a 1Hz buzzer prompt. When the scheduled time is over, the flame will be automatically extinguished with the sound of 10 beeps. The display will show "En" until the knob is turned off.
- 6 **To cancel the timing during use**
 - 1) Set the time to "0". The display will then turn off after 5s and exit the timing mode.
 - 2) To cancel the timing during timing setting and timing initiation, press and hold the "⏻" button for more than 2s. The display will then turn off and exit the timing mode.

Remarks

- 1) The burner of the stove has a timer function.
- 2) The stove should never be operated without supervision even if the timer function is used.
- 3) In the event the power supply is unexpectedly cut off or there is insufficient battery power, the flame in the burner will be immediately extinguished.
- 4) This timer displays each unit as minutes. If the countdown display is less than 1 minute, the displayed unit will convert into seconds.

| Timer malfunction code and coping methods | | | |
|---|---|--------------|--|
| Status | Situation | Code Display | Handling Methods |
| "Timing End" prompt | Prompt tone and the "En" display will disappear after 10 seconds after which this will repeat every 5 minutes until switching off the knob. | En | Switch off the knob and restart |
| "Thermocouple valve" alarm | Prompt tone and "E1" display disappear after 10s until switching off the knob. | E1 | Replace solenoid valve or initiate igniter |
| "Insufficient battery power" prompt | Prompt tone and "Lo" display disappear after 10s | Lo | Replace the solenoid battery |

清潔及保養 Cleaning And Maintenance

注意!

- 當爐具尚熱時,切勿進行清潔。
- 用柔軟的濕布及中性洗潔精輕抹玻璃面板部份。
- 用暖水及洗潔精清理爐蓋及爐架。

| 檢查 | 現象 |
|----|----|
|----|----|

大爐蓋
小爐蓋及爐架

〉

定期清潔爐頭及爐架上的油污,以保持爐頭出氣孔暢通。如煮食時有食物溢瀉,應盡快把爐頭清理乾淨。若爐蓋積有污垢,可把爐蓋取出用水或稀釋洗潔精沖刷亦可使用尖幼物件疏通爐頭氣孔以免爐頭氣孔阻塞。沖洗清潔後,待乾透。

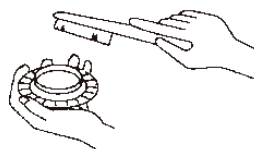

大爐蓋
小爐蓋及爐頭座

〉

留意正確放置位置,如大爐蓋、小爐蓋及爐頭座放置不正確,會導致燒壞爐蓋,更有可能引致玻璃爆裂。

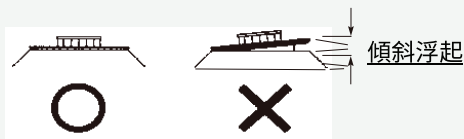

玻璃面板

〉

爐面及飾板有污垢,可用溫和洗潔精清洗,切勿使用天拿水或化學溶劑,以免損害爐面及飾板的光澤。

安全感應頭

〉

切勿使用金屬刷清潔,應用乾布清潔。

氣體接駁喉管

〉

如發現喉管破裂或未接駁好,請聯絡註冊氣體裝置技工或氣體供應商更換或重新接駁。

Attention!

- Do not clean the appliance when it is hot.
- Wipe the glass panel with a soft, damp cloth and mild detergent.
- Wash the larger or inner burner caps and pan supports in warm water and detergent.

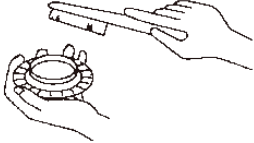
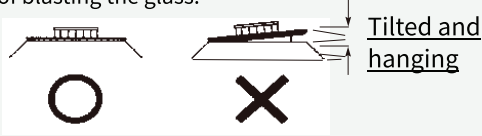
| Unit parts | Maintenance |
|--|--|
| Larger burners caps inner burner caps and pan supports | <p>Clean the grease on the burner caps and the pan supports regularly so as to keep the burner caps holes unblocked. In case something spills over, clean the burner caps as soon as possible. Take out the burner caps regularly, clean them with water or mild detergent. Sharp objects may be used to clean burner holes to avoid any blockages. After washing the burner caps, let them dry thoroughly.</p>  |
| Larger burners caps Inner burner caps and burner base | <p>Make sure the burner caps are mounted in place. Incorrect placement of the larger burner caps, inner burner caps and burner base will result in the burnout of the burner caps and the possibility of blasting the glass.</p>  |
| Glass panel | <p>When the glass top panel gets dirty, use a soft cloth dampened with a mild detergent solution to wipe off the dirt. Do not use any thinner or benzene for cleaning as this may damage the glass top panel.</p> |
| Flame sensor | <p>Do not clean the flame failure sensor with a wire brush. Clean it with a dry cloth instead.</p> |
| Gas tubing | <p>If there are cracks in the gas tubing or if it is not connected well, please contact a registered gas installer or the gas supply company to replace or reconnect it.</p> |

常見故障及處理方法 Trouble Shooting

| 現象 | 原因 | 處理方法 |
|--------|------------------|---|
| 點火不靈 | 氣源開關未開 | › 打開氣源開關 |
| | 電池已耗盡 | › 更換新電池 |
| | 氣瓶餘下氣量不足 | › 更換新的石油氣瓶 |
| | 開關掣按壓錯誤或按壓的時間不足 | › 回到熄火狀態，用力將旋鈕按到底慢慢逆時針旋轉，燃點後持續按壓數秒鐘 |
| 爐頭沒有火焰 | 仍未開啓燃氣錶控制閥或爐具切斷閥 | › 完全開啓燃氣錶控制閥或爐具切斷閥 |
| | 錫紙阻塞爐蓋 | › 除掉錫紙 |
| 發現有氣體味 | 喉管破裂或未接駁好 | › 煤氣型號 應立即關掉氣錶上游的緊急控制閥 |
| | 閥體漏氣 | › 石油氣型號 拔掉連接石油氣瓶的調壓器以截斷氣體供應，弄熄所有明火並盡量打開門窗，讓氣體消散。聯絡氣體供應商或註冊氣體裝置技工檢查 |
| 黃火 | 爐蓋積聚油漬或污垢 | › 以暖水和洗潔精清洗爐蓋，然後抹乾並放好 |
| 火焰不穩 | 爐蓋未放好 | › 重新放好爐蓋 |
| | 爐蓋變形 | › 聯絡代理商更換零件 |

* 若按上述方法仍無法點火，請即聯絡代理商作維修，切勿使用其他方法點火

* 如火焰不均或回火，導致火焰不完全燃燒，有機會導致一氧化碳中毒。

| Trouble | Cause | Solution |
|---------------------------|--|--|
| Burners cannot be ignited | The main gas supply is turned off. | Turn on the main gas supply. |
| | Out of battery. | Replace a new battery. |
| | Not enough gas in the gas cylinder. | Replace a new gas cylinder. |
| | The ignition knob is not pressed properly or adequately. | Turn it back to the turned off mode. Then, press and turn it anti-clockwise slowly. Once the burner is ignited, keep pressing it for a few seconds. |
| No flame | The gas meter control valve or the stove's shut-off valve has been turned off. | Open the gas meter cock or the appliance isolating cock completely. |
| | Burner cap is blocked by aluminium foil. | Remove the aluminium foil. |
| Smell of gas | The gas pipe had been damaged or not connected well. | <u>Town Gas models</u> Stop the gas flow immediately by turning off the emergency control valve upstream of the gas meter. |
| | The gas valve is leaking. | <u>Liquefied petroleum gas (LPG) models</u> Disconnect the regulator of the LPG cylinder to cut off gas supply. Extinguish all naked flames and open all windows and doors wide to disperse the gas. Contact the gas supply company or a registered gas installer for checking. |
| Yellow flame | Grease and dirt is accumulated on the burner cap. | Wash the burner cap in warm water with detergent. Dry it and place it back properly. |
| Unstable flame | The burner cap is not placed properly. | Replace the burner cap properly in position. |
| | Deformation of burner cap. | Contact the sole agent to replace the parts. |

*If the cooking range still cannot be ignited with the above suggested solutions, do not attempt to ignite it by other means. Please contact the sole agent for repair.

*If the flame becomes unstable or if there is the occurrence of a flashback, which leads to incomplete combustion, this may cause carbon monoxide poisoning.

技術規格 Specifications

| | | |
|--|---|----------------------------------|
| 型號 Model | LGC01CNB-TN | LGC01CNB-LN |
| 氣體 Gas type | 香港煤氣 HK town gas | 香港石油氣 HK LP gas |
| 熱負荷 (kW) Rated heat input (kW) | 6.0 | 5.0 |
| 燃氣入口接駁 Gas inlet connection | 1/2英寸英制陽螺旋紋 1/2" B.S.P (Male) | 1/2英寸英制陽螺旋紋 1/2" B.S.P (Male) |
| 氣體壓力 (Pa) Gas pressure (Pa) | 1500 | 2900 |
| 電源供應 Electric supply | DC 1.5V (D型乾電池) x 2 DC 1.5V (D Size) x 2 | |
| 點火方式 Ignition method | 電子點火 Electric ignition | |
| 產品尺寸 闊 x 深 x 高 (毫米) Product dimensions WxDxH(mm) | 310 x 520 x 145 (height to pan support/高度至爐架) | |
| 開孔尺寸 闊 x 深 (毫米) Cut-out dimensions WxD(mm) | 265 x 490 | |

注意 Cautions

1) 禁止使用錫紙碟 Never use aluminum tray.

2) 產品規格及設計如有變更,恕不另行通知。

Specifications are subject to change without prior notice.

3) 中英文版本如有出入,一概以中文版本為準。

If there is any inconsistency or ambiguity between the English version and the Chinese version, the Chinese version shall prevail.