



## 嵌入式三頭氣體煮食爐 Built-in three burner gas hob

LGC03CNL (香港石油氣 HK LP GAS)  
LGC03CNT (香港煤氣 HK Town GAS)

### 用戶手冊 User's Manual

感謝您購買本公司的產品，使用產品前，請務必注意安全操作須知。請在閱讀後，妥善保管好說明書以備查閱。  
因為本公司的產品會不斷改進，如有變更，恕不另行通知。

Thank you for purchasing our product. Before using the product make sure that you have followed the safety instructions. Please keep this manual for future reference. There will be increase improvements on our products. Information is subject to change without prior notice.

總代理：星暉爐具貿易有限公司 Sole Agency: Lighting Gas Stoves Trading Ltd.  
香港新界荃灣半山街10-16號富華工業大廈13樓C&D室  
Flat C&D, 13/F., Fou Wah Industrial Bldg., 10-16 Pun Shan Street, Tsuen Wan, N.T, H.K.  
Tel: (852) 2490 0073

Further information can be found at [www.lightinggas.com.hk](http://www.lightinggas.com.hk)  
© Copyright by Lighting Gas Stoves Trading Ltd.

# 內容 Content

氣體接駁需知 Gas connection and warning .....	P.1
各部名稱 Parts identification .....	P.2
安裝前須知 Before installation .....	P.3
使用方法 Operating instructions .....	P.3 - 4
清潔及保養 Cleaning and maintenance .....	P.5 - 6
常見故障及處理方法 Trouble shooting .....	P.7 - 8
技術規格 Specifications .....	P.9

# 氣體接駁需知 Gas Connection and Warning

## 所有類型的氣體用具

使用認可印有機電工程署批准標記(例如·機電工程署批准 EMSD APPROVAL GTXXXX)的氣體接駁喉管連接爐具,或使用機電工程署接納的其他恰當方法。

## 注意!

根據香港氣體安全條例,任何氣體裝置工程,包括爐具和接駁喉管的安裝,必須由註冊氣體裝置技工執行,而該技工已於相關的氣體工程類別註冊及受聘於註冊氣體工程承辦商。

## All Types of Gas Appliances

Use approved gas tubing bearing Electrical and Mechanical Services Department (EMSD) approval mark (such as: 機電工程署批准 EMSD APPROVAL GTXXXX) for connection to appliances, or other appropriate methods accepted by EMSD.

## Attention!

According to the Gas Safety Ordinance of Hong Kong, any gas installation works including the installation of appliances and connection tubing must be undertaken by registered gas installers who are registered for the appropriate classes and are employed by registered gas contractors.

## 嵌入式煮食爐特別注意事項

- 1 當在灶櫃面安裝嵌入式氣體煮食爐時,灶櫃應設有透氣設施,以確保煮食爐在使用時操作正常,如果安裝爐具靠近於易燃物料附近(如木牆,木架),兩側的安裝間距需要有15厘米以上。

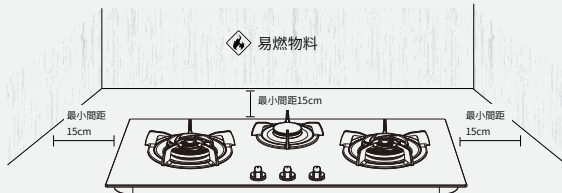

- 2 不應將易燃物料、噴霧及壓縮容器放置在灶櫃內。
- 3 切勿安裝外置氣體穩壓器。
- 4 切勿使用並非由製造商供應的配件,例如錫紙碟。
- 5 此煮食爐的面板是用強化玻璃製造,較一般玻璃安全。唯使用嵌入式玻璃面板煮食爐時還須注意以下事項,以避免造成玻璃面板爆裂
  - a. 經常清潔爐頭組件以保持爐蓋焰孔暢通,如溢出的食物及汁液,應在爐頭組件冷卻後儘快妥善清理。
  - b. 如煮食爐出現不尋常聲音,應立即停用並安排氣體供應公司或爐具進口商檢查。
  - c. 請勿放置過小、過大或過重的煮食器皿於爐架上,以免損壞爐架及令過多熱量反射回爐面,造成損壞。此煮食爐的最高負載重量為10公斤,平底鍋具最大直徑為26cm。
  - d. 切勿以硬物撞擊或將重物放置於玻璃面板。

## Additional Precautions for Built-in Hobs

- 1 When installing a built-in hob on top of a stove cabinet, please check that there is provision for ventilation at the cabinet to ensure proper operation of the gas hob. If the unit is to be installed close to combustible surroundings (such as wooden walls, wooden shelves), it should be installed at least 15cm from the side walls. The unit should be installed with a distance of at least 15cm away from surrounding combustible materials.

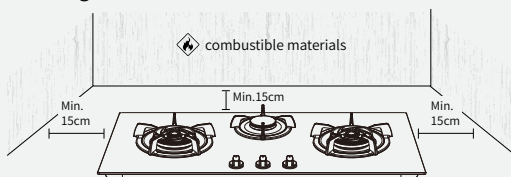

- 2 Do not store any flammable materials, sprays or pressurized containers inside the stove cabinet. Do not install with an external gas governor.
- 3 Do not use any additional fitting such as aluminum tray that is not supplied by the manufacturer.
- 4 The panel of this built-in hob is made of tempered glass, which is safer than normal glass for this appliance. However, the following safety precautions for using built-in hobs with a glass top panel should also be noted to prevent the glass top panel from breaking.
  - a. Clean the burner assembly frequently to maintain a clear gas passage on the burner cap. Clean and tidy up the flame distributor after spillage of food and liquid once the burner assembly cools down.
  - b. Turn off the gas appliance immediately if abnormal noise propagates from the gas appliance and contact the gas supply company or gas hob importer for inspection.
  - c. Do not use undersize, oversize or overweight cooking pots or receptacles, or they will damage the rack and cause excessive heat to be reflected back onto the range surface. This may increase the temperature of this area and may cause damage. The maximum load weight for this appliance is 10kg, the maximum pan size is 26cm.
  - d. Do not impact the glass surface with hard objects or place heavy objects on the glass surface.

## 各部名稱 Parts Identification

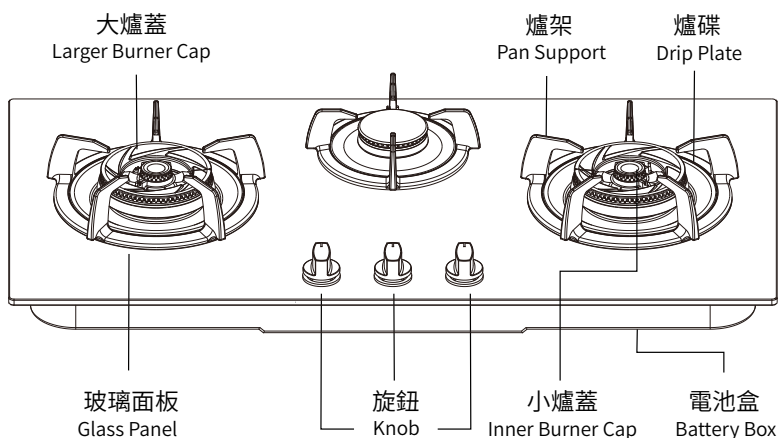

圖片只供參考·實際外形請參考實物

The figure is for reference purpose only. Please refer to the actual component parts.

## 安裝前須知 Precautions Before Installation

- 1 檢查爐具的零件是否齊全，完好。若發現有不齊或破損，請與購買商聯絡。
  - 2 在您選定的台面安裝位置，請按包裝箱內的台面開窿樣板尺寸開孔。
  - 3 於廚櫃枱面安裝嵌入式氣體煮食爐時，灶櫃應設有活風透氣設施，以確保煮食爐在使用正常。不要儲存任何易燃物料、噴霧或壓力容器在灶櫃內。
  - 4 爐具需與牆壁保持足夠距離，此爐具的安裝位置應與周圍易燃物料距離15 厘米以上，若爐具周圍與易燃物品沒有充分的空間，請安裝防熱板。
- 1 Check the quantity of the components and make sure all items are there. If there are some items missing or damaged in the packaging, please contact the dealer.
  - 2 Cut out the dimensions for the cabinet according to the template provided for reference on your selected countertop area.
  - 3 When installing a built-in gas hob on top of a stove cabinet, please check that there is provision for ventilation at the cabinet to ensure proper operation of the gas hob. Do not store any flammable materials, sprays or pressurized containers inside the stove cabinet.
  - 4 Allow the minimum required space from walls. A build-in hob should be installed with a distance of at least 15cm away from surrounding combustible materials. If the space between the cooker and combustible materials cannot be maintained as specified, make sure to install a heat-proof panel.

## 使用方法 Operating Instructions

- 1 點火
  - a. 請向下按緊旋鈕，並以逆時針方向旋至 [ 🔥 ] 位置，維持按壓約10秒鐘。  
放手時，請確認爐頭維持於燃燒狀態，如爐火仍未點燃，將旋鈕旋轉回 [ • ] 位置，
  - b. 等待最少於一分鐘後才可重覆以上步驟。

### 注意

當爐具被重新安裝或長時間沒有使用時，可能須要較長時間才可燃點爐火。

- 2 火力調節

順時針或逆時針旋轉即可進行火力調節

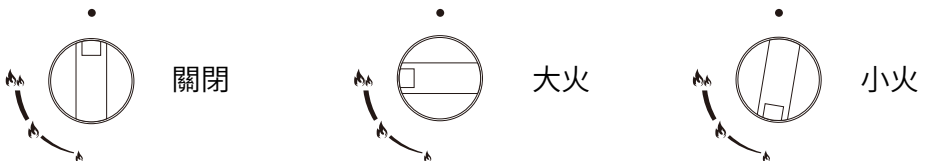

- 3 熄火

順時針將旋鈕旋至 [ • ] 位置。

### 注意

熄火時可能會發出“撲”的聲響，這是正常現象。

## 1 Ignition

- a. Press the knob and turn it anti-clockwise to the [ 🔥 ] position, then keep pressing for around 10 seconds. Release the knob and check if the flame is already ignited. If not, turn the knob back to the [ • ] position.
- b. You may repeat the above steps after at least 1 minute.

**Note:**

If the stove is not being used for a long time or has just been re-installed, it may take a longer time for ignition.

## 2 Flame Power Control

Rotate the knob clockwise or anti-clockwise to adjust the flame.

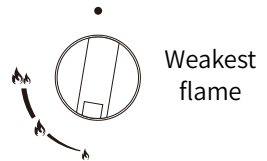
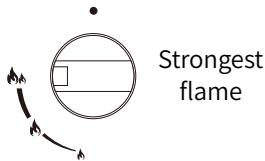
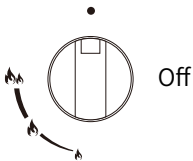

## 3 Turning Off

Turn the knob in a clockwise direction to the [ • ] position.

**Note:**

When turning off, a "POP" sound may be produced. This is normal.

# 清潔及保養 Cleaning And Maintenance

## 注意!

- 當爐具尚熱時,切勿進行清潔。
- 用柔軟的濕布及中性洗潔精輕抹玻璃面板部份。
- 用暖水及洗潔精清理爐蓋及爐架。

檢查	現象
----	----

大爐蓋  
小爐蓋及爐架

>

定期清潔爐頭及爐架上的油污,以保持爐頭出氣孔暢通。如煮食時有食物溢瀉,應盡快把爐頭清理乾淨。若爐蓋積有污垢,可把爐蓋取出用水或稀釋洗潔精沖刷亦可使用尖幼物件疏通爐頭氣孔以免爐頭氣孔阻塞。沖洗清潔後,待乾透。



大爐蓋  
小爐蓋及爐頭座

>

留意正確放置位置,如大爐蓋、小爐蓋及爐頭座放置不正確,會導致燒壞爐蓋,更有可能引致玻璃爆裂。

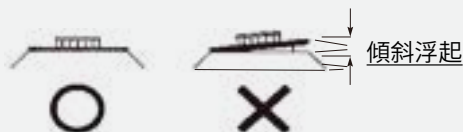

玻璃面板

>

爐面及飾板有污垢,可用溫和洗潔精清洗,切勿使用天拿水或化學溶劑,以免損害爐面及飾板的光澤。

安全感應頭

>

切勿使用金屬刷清潔,應用乾布清潔。

氣體接駁喉管

>

如發現喉管破裂或未接駁好,請聯絡註冊氣體裝置技工或氣體供應商更換或重新接駁。

## Attention!

- Do not clean the appliance when it is hot.
- Wipe the glass panel with a soft, damp cloth and mild detergent.
- Wash the larger or inner burner caps and pan supports in warm water and detergent.

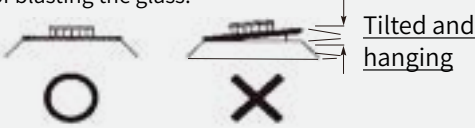
Unit parts	Maintenance
Larger burners caps inner burner caps and pan supports	<p data-bbox="406 395 1031 584">Clean the grease on the burner caps and the pan supports regularly so as to keep the burner caps holes unblocked. In case something spills over, clean the burner caps as soon as possible. Take out the burner caps regularly, clean them with water or mild detergent. Sharp objects may be used to clean burner holes to avoid any blockages. After washing the burner caps, let them dry thoroughly.</p> 
Larger burners caps Inner burner caps and burner base	<p data-bbox="406 794 997 903">Make sure the burner caps are mounted in place. Incorrect placement of the larger burner caps, inner burner caps and burner base will result in the burnout of the burner caps and the possibility of blasting the glass.</p> 
Glass panel	<p data-bbox="406 1066 1020 1174">When the glass top panel gets dirty, use a soft cloth dampened with a mild detergent solution to wipe off the dirt. Do not use any thinner or benzene for cleaning as this may damage the glass top panel.</p>
Flame sensor	<p data-bbox="406 1230 1025 1286">Do not clean the flame failure sensor with a wire brush. Clean it with a dry cloth instead.</p>
Gas tubing	<p data-bbox="406 1353 1029 1433">If there are cracks in the gas tubing or if it is not connected well, please contact a registered gas installer or the gas supply company to replace or reconnect it.</p>



## 常見故障及處理方法 Trouble Shooting

現象	原因	處理方法
點火不靈	氣源開關未開	› 打開氣源開關
	電池已耗盡	› 更換新電池
	氣瓶餘下氣量不足	› 更換新的石油氣瓶
	開關掣按壓錯誤或按壓的時間不足	› 回到熄火狀態，用力將旋鈕按到底慢慢逆時針旋轉，燃點後持續按壓數秒鐘
爐頭沒有火焰	仍未開啓燃氣錶控制閥或爐具切斷閥	› 完全開啓燃氣錶控制閥或爐具切斷閥
	錫紙阻塞爐蓋	› 除掉錫紙
發現有氣體味	喉管破裂或未接駁好	› <u>煤氣型號</u> 應立即關掉氣錶上游的緊急控制閥
	閥體漏氣	› <u>石油氣型號</u> 拔掉連接石油氣瓶的調壓器以截斷氣體供應，弄熄所有明火並盡量打開門窗，讓氣體消散。聯絡氣體供應商或註冊氣體裝置技工檢查
黃火	爐蓋積聚油漬或污垢	› 以暖水和洗潔精清洗爐蓋，然後抹乾並放好
火焰不穩	爐蓋未放好	› 重新放好爐蓋
	爐蓋變形	› 聯絡代理商更換零件

\*若按上述方法仍無法點火，請即聯絡代理商作維修，切勿使用其他方法點火

\*如火焰不均或回火，導致火焰不完全燃燒，有機會導致一氧化碳中毒。

Trouble	Cause	Solution
Burners cannot be ignited	The main gas supply is turned off.	> Turn on the main gas supply.
	Out of battery.	> Replace a new battery.
	Not enough gas in the gas cylinder.	> Replace a new gas cylinder.
	The ignition knob is not pressed properly or adequately.	> Turn it back to the turned off mode. Then, press and turn it anti-clockwise slowly. Once the burner is ignited, keep pressing it for a few seconds.
No flame	The gas meter control valve or the stove's shut-off valve has been turned off.	> Open the gas meter cock or the appliance isolating cock completely.
	Burner cap is blocked by aluminium foil.	> Remove the aluminium foil.
Smell of gas	The gas pipe had been damaged or not connected well.	> <u>Town Gas models</u> Stop the gas flow immediately by turning off the emergency control valve upstream of the gas meter.
	The gas valve is leaking.	> <u>Liquefied petroleum gas (LPG) models</u> Disconnect the regulator of the LPG cylinder to cut off gas supply. Extinguish all naked flames and open all windows and doors wide to disperse the gas. Contact the gas supply company or a registered gas installer for checking.
Yellow flame	Grease and dirt is accumulated on the burner cap.	> Wash the burner cap in warm water with detergent. Dry it and place it back properly.
Unstable flame	The burner cap is not placed properly.	> Replace the burner cap properly in position.
	Deformation of burner cap.	> Contact the sole agent to replace the parts.

\*If the cooking range still cannot be ignited with the above suggested solutions, do not attempt to ignite it by other means. Please contact the sole agent for repair.

\*If the flame becomes unstable or if there is the occurrence of a flashback, which leads to incomplete combustion, this may cause carbon monoxide poisoning.

# 規格 Specifications

型號 Model	LGC03CNT	LGC03CNL	
氣體 Gas type	香港煤氣 HK town gas	香港石油氣 HK LP gas	
熱負荷 (kW)	右爐頭 Right burner	6.0	5.0
	中爐頭 Middle burner	2.5	1.6
	左爐頭 Left burner	6.0	5.0
燃氣入口接駁 Gas inlet connection	1/2英寸英制陽螺旋紋 1/2" B.S.P (Male)	1/2英寸英制陽螺旋紋 1/2" B.S.P (Male)	
氣體壓力 Gas pressure	1500Pa	2900Pa	
電源供應 Electric supply	DC 1.5V ( D型乾電池) x 1 DC 1.5V (D Size) x 1		
點火方式 Ignition method	電子點火 Electric ignition		
產品尺寸 闊 x 深 x 高 (毫米) Product dimensions WxDxH(mm)	860 x 450 x 125 (height to pan support/高度至爐架)		
開孔尺寸 闊 x 深 (毫米) Cut-out dimensions WxD(mm)	815 x 405		

## 注意 Cautions

- 1) 禁止使用錫紙碟 Never use aluminum tray.
- 2) 產品規格及設計如有變更,恕不另行通知。  
Specifications are subject to change without prior notice.
- 3) 中英文版本如有出入,一概以中文版本為準。  
If there is any inconsistency or ambiguity between the English version and the Chinese version, the Chinese version shall prevail.